

KENWOOD

CASSETTE-TUNER

KRC-940

INSTRUCTION MANUAL

KENWOOD CORPORATION

Take the time to read through this instruction manual. Familiarity with installation and operation procedures will help you obtain the best performance from your new cassette-receiver.

For your records

Record the serial number, found on the back of the unit, in the spaces designated on the warranty card, and in the space provided below. Refer to the model and serial numbers whenever you call upon your KENWOOD dealer for information or service on the product.

Model KRC-940 Serial number _____

SAFETY PRECAUTIONS

▲ WARNING

Observe the following instructions to prevent fires and personal injury.

- To prevent the possibility of injury due to a shock from a collision causing the faceplate to fly off and strike a passenger, always make sure the faceplate is securely locked in place when attaching it to the unit.
- When the Power supply lead, Memory backup lead or Ground lead are extended, use a 0.75 mm² (AWG 18) or larger automotive grade cable which will withstand friction and heat to safe guard against fires occurring as a result of short-circuiting.
- Make sure that metal objects, particularly needles or coins do not get into the unit to prevent short-circuiting and fires.
- If smoke comes out of the unit or a strange smell is present, disconnect the unit immediately and consult your KENWOOD dealer. Continued use under these circumstances could cause a fire as well as damage the unit permanently.

FCC WARNING

This equipment may generate or use radio frequency energy. Changes or modifications to this equipment may cause harmful interference unless the modifications are expressly approved in the instruction manual. The user can lose the authority to operate this equipment if an unauthorized changes or modification are made.

▲ CAUTION

Heed the following instruction to keep the unit in proper working order.

- The unit should be connected to a 12 V DC power supply with a minus ground connection.
- Do not open enclosures, such as the front panel, top or bottom covers.
- Do not place the unit, where it will be exposed to direct sunlight or near heating devices.
- Do not expose the unit to water.
- Do not place the unit in areas of excessive dust, high humidity or on unstable surfaces.

This unit is equipped with a theft deterrent faceplate. To prevent damage to the faceplate and case, it is important to observe the following precautions.

- The faceplate and case may become deformed or damaged if subjected to high temperatures. Do not place the faceplate or case in direct sunlight or near a source of heat.
- Do not expose the faceplate or case to water.
- The faceplate is a precision component and may become damaged if struck by a hard object, dropped onto a hard surface, stepped on, or subjected to any other type of shock. If a shock is applied while the faceplate is in the case, the case may open causing the faceplate to fly out and become damaged.
- Do not touch the faceplate terminal or faceplate mount terminal with your fingers.

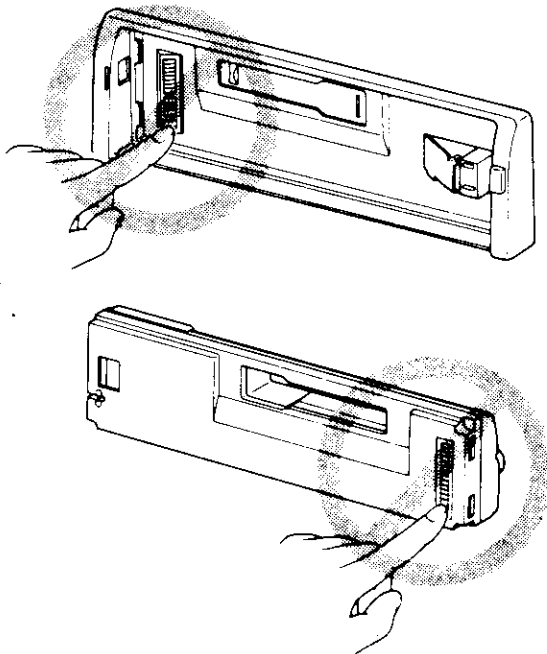

NOTE

- If you have difficulty in installing the set in your car, please contact your KENWOOD dealer.
- If your set malfunctions or operates abnormally, first press the Reset button. If the malfunction persists, leave the set as it is and please call your KENWOOD dealer.

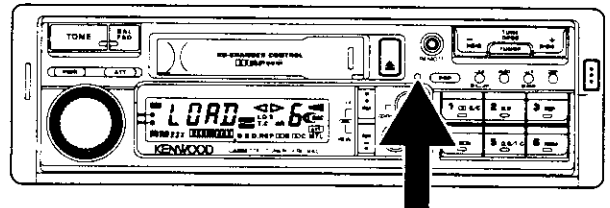

Reset button

Notes on handling tape

- Before loading a cassette, check the tape for slack. If there is slack tape, remove it by using a pencil to turn one of the spools in the cassette shell. Playing a slack tape in the deck can cause the tape to become wound around the pinch roller. This is just one of many problems that can result.
- Do not expose a cassette tape to direct sunlight. Leaving a cassette tape in a place where the temperature and humidity are high can deform the cassette shell and the tape itself. Do not use such tapes in your unit as it may not be possible to eject them.
- A 120-minute tape is very thin and its use should be avoided as it can easily become twisted around the pinch roller.

CARE AND MAINTENANCE

Cleaning

1. Turn the power off, before cleaning the unit.
2. Wipe the front panel and other exterior surfaces of the unit with a soft dry cloth or a soft cloth lightly moistened with a neutral detergent.

▲ CAUTION

- Do not use abrasive pads, thinner or benzene (or other volatile solvents) to clean the unit as this may remove indicator characters.

Head cleaning

Magnetic particles from the tape adhere to the head surface after a long period of use, resulting in noise and poor quality sound. Clean the head with a cleaning tape available at your KENWOOD dealer, following the directions in the head cleaner.

Faceplate terminal cleaning

If the faceplate terminal or faceplate mount terminal becomes dirty, wipe clean with a soft, dry cloth.

TABLE OF CONTENTS

	Page
■ Introduction	
SPECIAL FEATURES	6
■ Your new Cassette-receiver	
POWER AND VOLUME	8
SEEK TUNING (Local seek tuning)	9
MANUAL TUNING	10
TAPE PLAY	11
TAPE SELECTOR AND DOLBY NR	12
LOUDNESS	13
TONE CONTROL	14
BALANCE/FADER CONTROL	16
■ Special Tuner features	
PRESET STATION TUNING	18
AUTO MEMORY	19
PRIORITY RADIO PRESET	20
■ Special Tape deck features	
DIRECT PROGRAM SEARCH SYSTEM	21
INDEX SCAN	22
REPEAT PLAY	23
BLANK SKIP	24
TUNER CALL	25
■ Playing the CD auto changer	
COMPACT DISC PLAY	26
TRACK/DISC SEARCH	27
■ Special CD auto changer features	
TRACK/DISC REPEAT	28
TRACK SCAN	29
DISC SCAN	30
RANDOM PLAY	31
■ Useful features	
HOW TO OPERATE KCA-R2 (Optional)	32
CLOCK INDICATION AND ADJUSTMENT	34
SELECTABLE ILLUMINATION	35
PHONE INTERFACE	36
THEFT DETERRENT FACEPLATE	37
CHANNEL SPACE SELECTION	38
■ Installation	
ACCESSORIES	39
PROCEDURE	40
CONNECTIONS	41
INSTALLATION	42
■ TROUBLESHOOTING GUIDE	44
■ SPECIFICATIONS	46

Dolby noise reduction manufactured under license from Dolby Laboratories Licensing Corporation.

"DOLBY" and the double-D symbol are trademarks of Dolby Laboratories Licensing Corporation.

SPECIAL FEATURES

■ Tuner section

- **Seek tuning (P. 9)**
Automatically locates and receives stations.
- **Preset station tuning (P. 18)**
Registers the frequency of your favorite stations in memory to allow one-touch tuning.
- **Auto memory (P. 19)**
Automatically stores the frequency of a station that provides the best reception quality in memory. Once a station is stored, it can be accessed through preset station tuning.
- **Priority radio preset (P. 20)**
A station can be stored in the priority preset for instant recall through a one-touch function regardless of the operating mode the tuner is in. This allows quick and easy access to station that you often listen to (e.g. news, traffic information stations, etc.).

■ Tape deck section

- **Auto tape selector (P. 12)**
When a tape is inserted, the deck determines whether the tape is a metal (chrome) tape or a normal tape and automatically sets the tape position accordingly.
- **Direct program search system (P. 21)**
This function lets you search for tunes up to 9 positions before or after the currently playing tune.
- **Index scan (P. 22)**
This function automatically plays the first part of each tune on the tape in sequence. This can be very helpful when searching for a certain tune.
- **Repeat play (P. 23)**
Use this function when you want to play the same tune repeatedly.

- **Blank skip (P. 24)**
When a blank section longer than 10 seconds is detected on the tape, the deck automatically fast-forwards to the beginning of the next tune.
- **Tuner call (P. 25)**
Allows you to listen to the tuner during tape rewind or fast-forward.

■ CD auto changer control section

- **CD auto changer control (P. 26~31)**
This device allows you to control the CD auto changer.
- **Track/disc repeat (P. 28)**
The same track or the same disc is played repeatedly. This function is useful when you want to listen to a certain tune or disc more than once.
- **Track scan (P. 29)**
Plays back short snatches of each track on a CD starting from the beginning. This is a convenient feature when searching for a track you would like to listen to.
- **Disc scan (P. 30)**
Plays the first part of each disc in the CD magazine in sequence. This function is useful when you cannot remember the disc number of the CD you want to listen to or when you want to find out what CDs are loaded in the disc magazine.
- **Random play (P. 31)**
Allows you to listen to the tracks of a compact disc in random order.

■ Useful features

- **Remote control (P. 32)**
When used with the separately-sold KCA-R2 remote controller, this unit can be operated by wireless remote control.
- **Clock indication (P. 34)**
Displays the time in the display window.
- **Selectable illumination (P. 35)**
The color of illumination can be switched between green and orange.
- **Phone interface (P. 36)**
When the phone interface lead is connected to a car telephone, the player automatically pauses to cut the sound whenever a telephone call is received.
- **Theft deterrent faceplate (P. 37)**
When you leave the car, you can easily take the faceplate with you. This helps you to prevent theft.
- **Channel space selection (P. 38)**
Allows you to switch the channel space between FM: 200 kHz/AM: 10 kHz and FM: 50 kHz/AM: 9 kHz.
- **Automatic illumination**
Connected the Automatic illumination control lead, during the power is OFF, turning ON the car's light control the illumination light up.

POWER AND VOLUME

POWER ON/OFF

Press the Power switch or perform an operation for one of the modes (see P. 9 ~ 11/26).
(The power goes ON.)

Press the Power switch again.
(The power goes OFF.)

ALL MODE STAND BY

Press the Tuner switch while in tuner mode.
(The power remains in the ON condition and wait for operation of each mode state.)

OFF

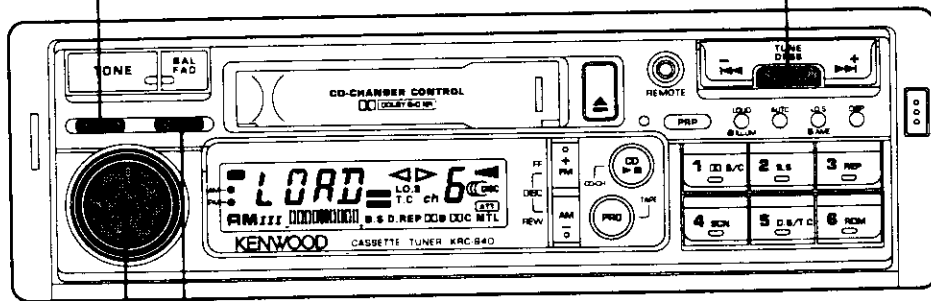

VOLUME CONTROL

Turning this knob clockwise, increases the volume, and turning counterclockwise, decreases.
(The Volume indicator shows the adjustment level.)

92.1

FM I



decreases increases

ATTENUATOR VOLUME

Press the Attenuator switch.
(The "ATT" indicator blinks and the volume is decreased.)
Press the Attenuator switch again.
(The "ATT" indicator goes out and the volume returns to the original level.)

92.1

FM I



NOTE

- Turning the power ON automatically turns this unit to the same mode before turning OFF the power.
(When the power is turned on for the first time, the unit enters the All Mode Stand-by state.)
- Perform the following operations with the power on.

SEEK TUNING

LISTENING TO THE TUNER

Press the Tuner switch.
(Tuner reception begins.)

1

Select the desired Band.

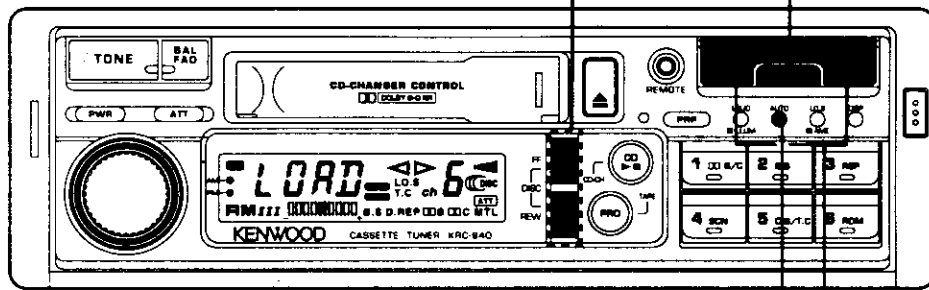
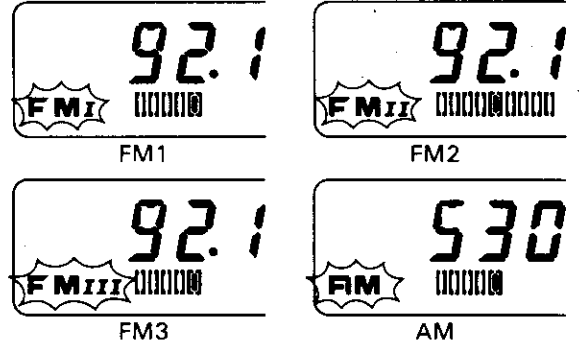
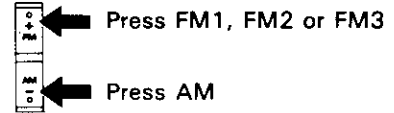

2

Turn the Auto switch ON.



ON

3

Press the Seek switch.
(Seek starts and receives a broadcast station.)

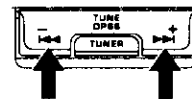

Down Seek Up Seek



Indicates reception frequency.
Lit when FM stereo broadcast is received.

< Local seek tuning >

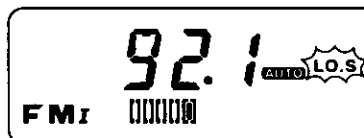
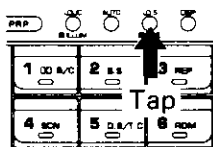

ON

- If the Local seek switch is turned ON during SEEK TUNING and AUTO MEMORY, it will stop at stations only with satisfactory reception conditions:

MANUAL TUNING

LISTENING TO THE TUNER

Press the Tuner switch.
(Tuner reception begins.)

1

Select the desired Band.

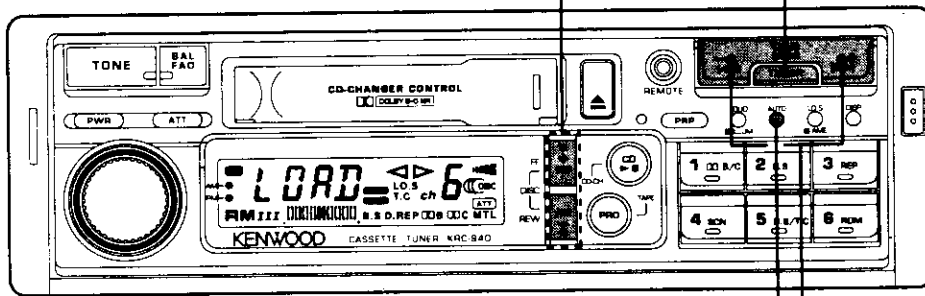
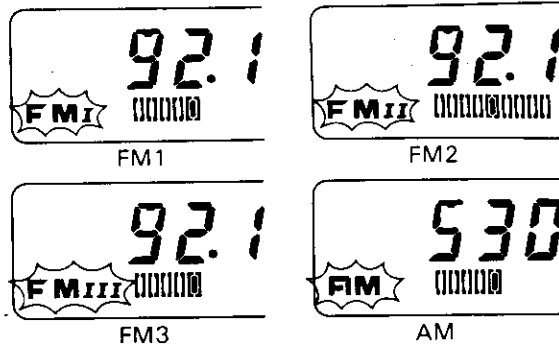
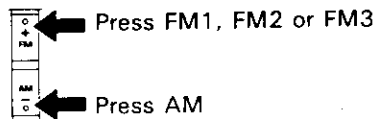

2

Turn the Auto switch OFF.

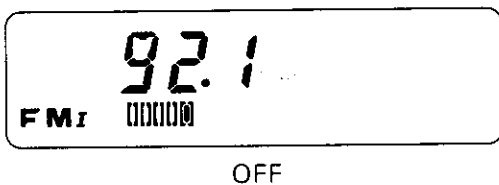

3

Press to select the desired frequency.
(Indicates the frequency being received.)

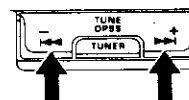

For lower frequencies For higher frequencies

(Continued pressing will change it continuously.)

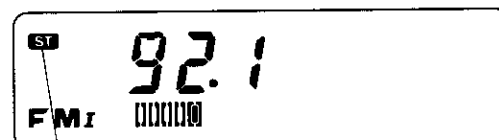

Indicates reception frequency
Lit when FM stereo broadcast is received.

TAPE PLAY

TAPE PLAY

Insert the cassette tape with the exposed tape facing to the right. While a cassette tape is inserted in the unit, press Program/Play switch. (TAPE indication is shown and the playback will start.)



STOP TAPE PLAY

Press the Eject switch. (The cassette tape will come out.)

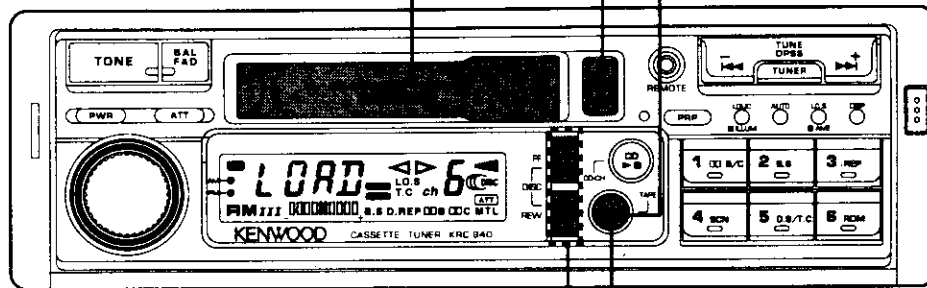

FAST-FORWARD/REWIND

Operation	Press
Fast-forward	FF
Rewind	REW

To release, press the Program/Play switch.

PROGRAM

When you wish to listen to the reverse side, press the Program/Play switch. (The reverse side will be played back.)

< Tape play side >

When inserted with the side A up.

Indicator	Tape play side
▷	Side A
◁	Side B
◁▷	Tape play is stopped. (A tape is loaded but the unit is in another mode.)

This will be reversed when inserted with the side B up.

TAPE SELECTOR AND DOLBY NR

TAPE SELECTOR

When a metal (chrome) tape is inserted, the Metal indicator comes ON, and the equipment is automatically set to the metal (chrome) tape position.



Metal/Chrome tape position

DOLBY B/C NR

In tape play mode, press Dolby B/C NR switch when playing back a tape recorded with Dolby B/C NR system.

(The modes shift in sequence from Dolby B NR ⇒ Dolby C NR ⇒ OFF ⇒ Dolby B NR each time a switch is pressed.)



DOLBY B NR ON



DOLBY C NR ON

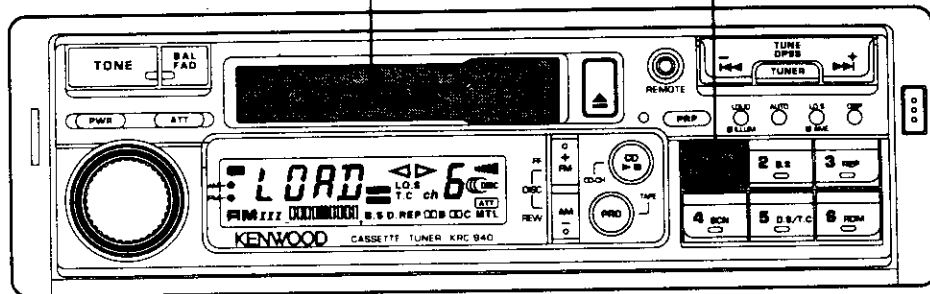

LOUDNESS SWITCH

When listening at low volume levels, tap this switch will activate the loudness circuit which will compensate for the human ear's decreased response.



ON

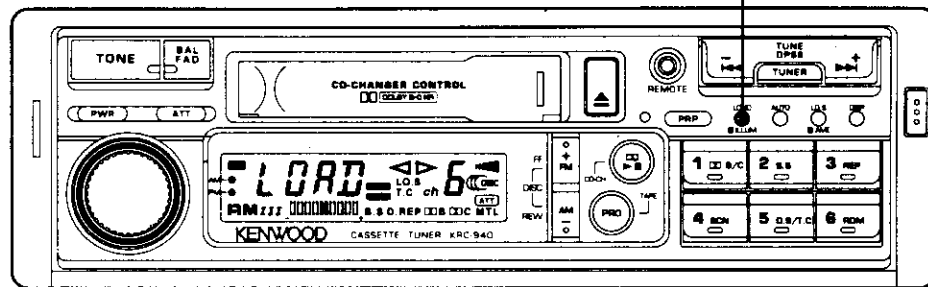

TONE CONTROL

1

Press the Tone switch will enable the Tone control. Unless it is pressed, Volume and it becomes possible to adjust in the order of Bass, Mid-Bass and Treble and back to Volume if tapped every time.

2

Adjustment will be made by the Tone controller respectively. For operations and display, refer to the following table.

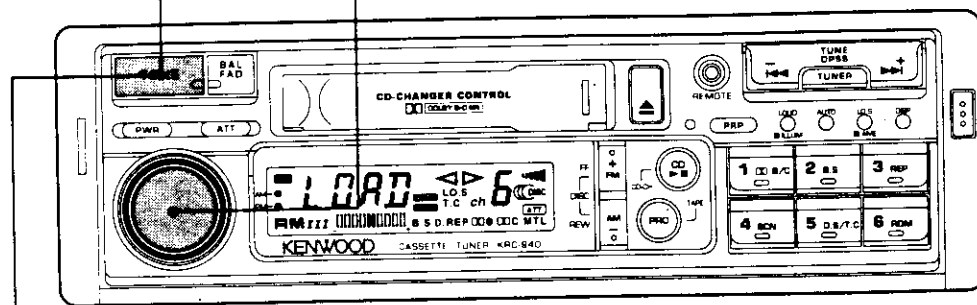

TO RELEASE

If the Tone switch is pressed for more than 1 second or if no operation is performed within 5 seconds, the unit returns to the volume adjustment mode.

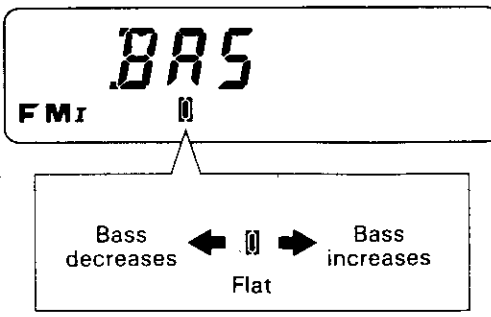
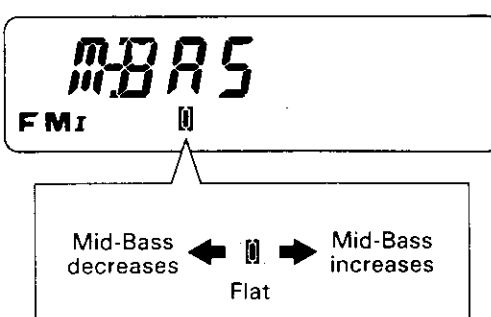
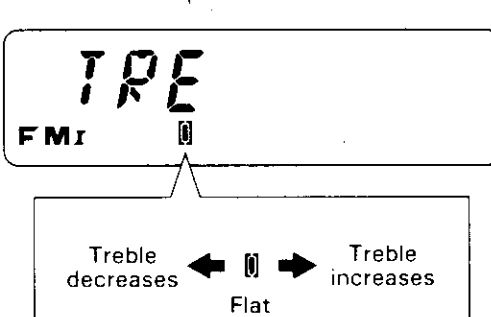
Display	Operation of Tone controller	
	Turn counterclockwise	Turn clockwise
<p>Adjust the Bass response</p> 	Bass decreases.	Bass increases.
<p>Adjust the Mid-Bass response</p> 	Mid-Bass decreases.	Mid-Bass increases.
<p>Adjust the Treble response</p> 	Treble decreases.	Treble increases.

BALANCE/FADER CONTROL

1

Press the Balance/Fader switch will enable the Balance/Fader control. Unless it is pressed, Volume and it becomes possible to adjust in the order of Balance and Fader and back to Volume if tapped every time.

2

Adjustment will be made by the Balance/Fader controller respectively.
For operations and display, refer to the following table.

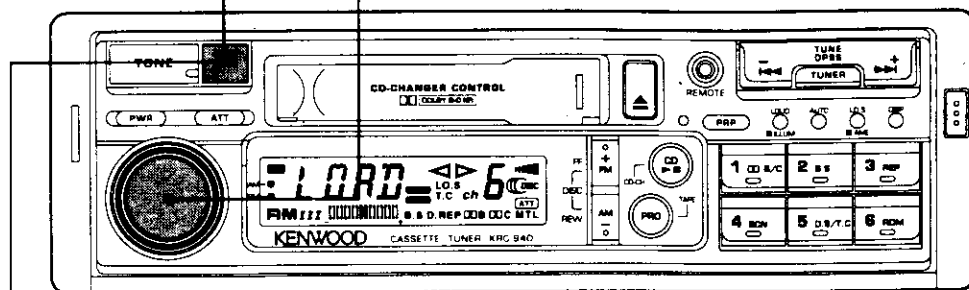

TO RELEASE

If the Balance/Fader switch is pressed for more than 1 second or if no operation is performed within 5 seconds, the unit returns to the volume adjustment mode.

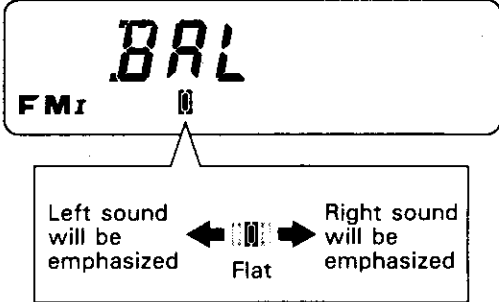
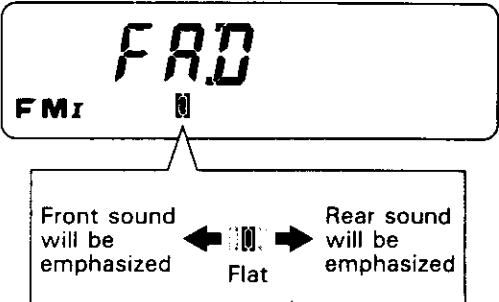
Display	Operation of Balance/Fader controller	
	Turn counterclockwise	Turn clockwise
<p>Adjust the Balance of the right and left channels</p> 	<p>The left sound will be emphasized.</p>	<p>The right sound will be emphasized.</p>
<p>Adjust the Balance of the front and rear channels</p> 	<p>The front sound will be emphasized.</p>	<p>The rear sound will be emphasized.</p>

PRESET STATION TUNING

1

Selects the band and station you wish to preset.

2

Press the Preset station switch you wish to be kept preset for more than 2 seconds.

(When it is preset, the number of switch pressed will be indicated.)

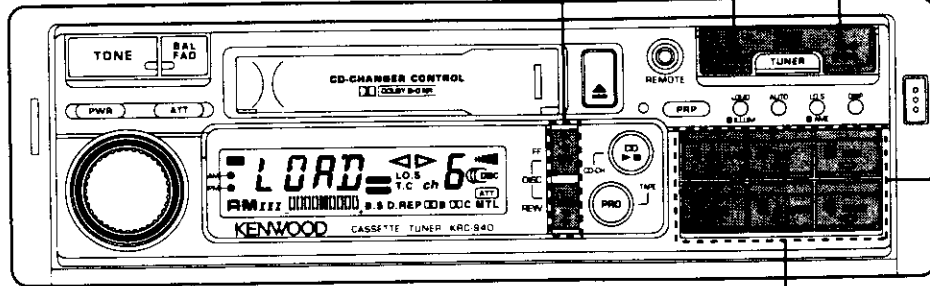
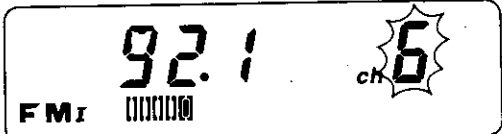

3

By repeating operation of 1 - 2 above, one station can be memorized in one switch each at FM1, FM2, FM3 and AM.

4

If tapped, the preset station can be called out.

(The number of switch pressed will be indicated.)

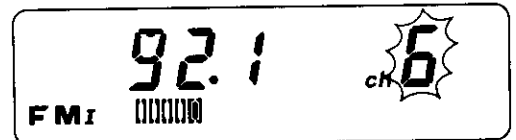

NOTE

- If preset is to be made anew on the switch already preset, what was preset before will be replaced with what is to be preset.

AUTO MEMORY

1

Select the desired Band.

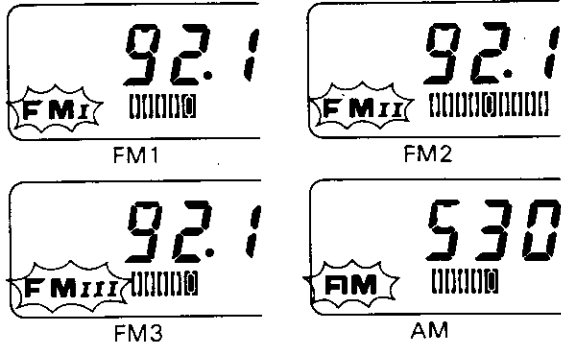
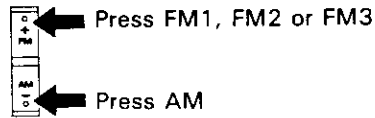

2

Press the Auto memory switch for more than 2 seconds.
(The "ch" indicator blinks.)

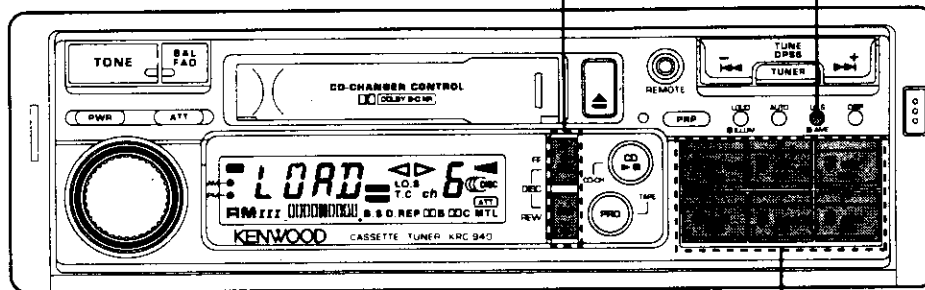
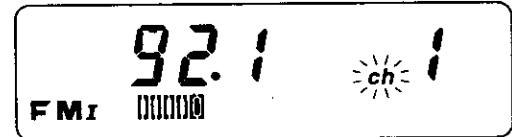

3

The selected band is automatically scanned and 6 stations are memorized. When 6 stations are memorized, the AUTO MEMORY function is automatically released.
(The station last stored in memory is received.)

4

If tapped, the preset station can be called out.
(The number of switch pressed will be indicated.)

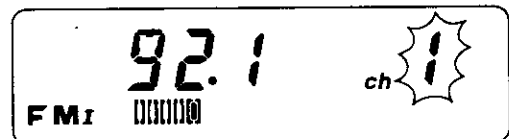

PRIORITY RADIO PRESET

1

Press the Priority radio preset switch.
(The  indicator lights when a station is received.)
In factory setting, the tuner receives a station at 87.9 MHz.

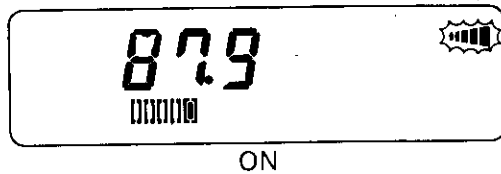

TO RELEASE

Press the Priority radio preset switch again.
(The  indicator goes off and the tuner returns to the previous mode.)

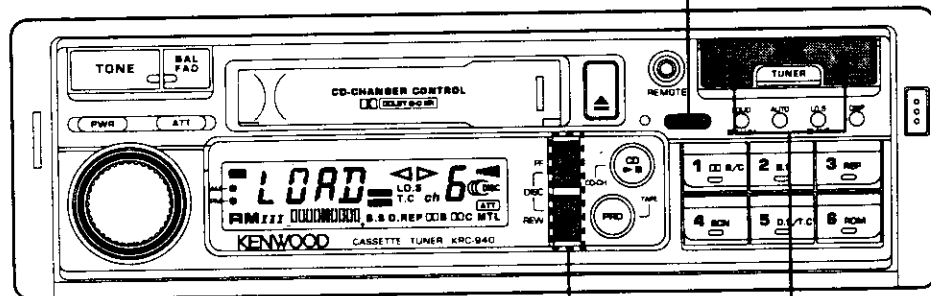

Modifying priority radio presetting

After step 1, tune in the desired station with the priority radio preset function.
(This station will be preset next time.)

NOTE

- Only seek tuning and manual tuning can be used in PRIORITY RADIO PRESET mode.

DIRECT PROGRAM SEARCH SYSTEM

1 BACKWARD SEARCH

Press the ◀◀ switch a number of times equal to the number of tunes you want to skip.

Up to 9 tunes can be skipped.

(The number of programs to be skipped is displayed blinking on the program count display.)

Example:



...When pressed once
(Searching the beginning
of present program)



...When pressed 4 times
(Searching the third
program before the
present program)

1 FORWARD SEARCH

Press the ▶▶ switch a number of times equal to the number of tunes you want to skip.

Up to 9 tunes can be skipped.

(The number of programs to be skipped is displayed blinking on the program count display.)

Example:



...When pressed once
(Searching the beginning
of the next program)



...When pressed 5 times
(Searching the fifth
program after the
present program)

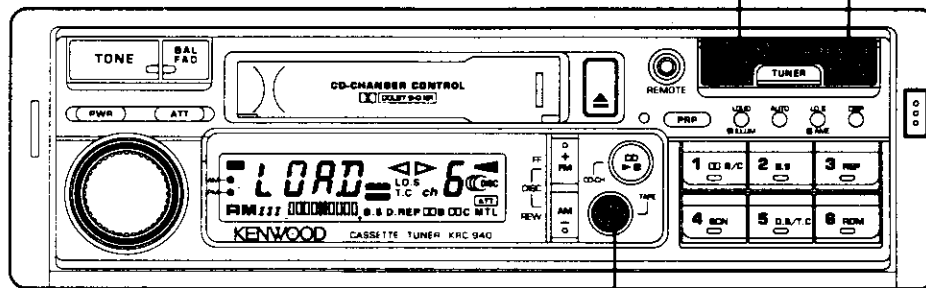

2

The rewind or fast forward operation is released when the beginning of the program selected in step 1 is detected, and tape playback starts from that position.

TO RELEASE

Press the Program/Play switch to release the Direct Program Search in the middle.

NOTE

- Please note that in case of the following tapes, sometimes the Direct program search system does not function properly.
 - When an interval between the music is less than 5 seconds.
 - When a recorded portion of the low sound volume continues for more than 5 seconds.
- If you press the ◀◀ switch within three seconds after a tune starts playing, the previous tune will be counted as the "0" tune.

INDEX SCAN

1

Press the Index scan switch.
(While in the Index scan mode, the below indication is repeated.)

TAPE 

2

Tape is fast forwarded until the beginning of the next program is searched.

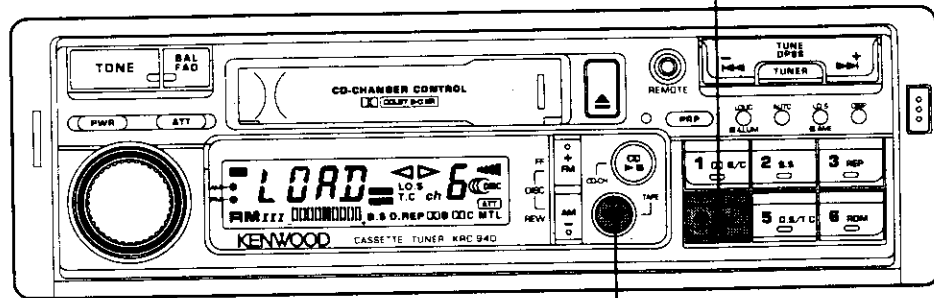

3

After the beginning of the searched program is played, the tape is fast forwarded again, and repeats the same operations for other programs on tape.

4

When the beginning of a desired program starts to be played, press the Program/Play switch.
(Index scan is released and normal tape playback starts.)

NOTE

- Please note that in case of the following tapes, sometimes the INDEX SCAN does not function properly.
 - When an interval between the music is less than 5 seconds.
 - When a recorded portion of the low sound volume continues for more than 5 seconds.

1

Press the Repeat switch at the track you wish to listen to repeatedly.
(Repeat indicator lights up.)

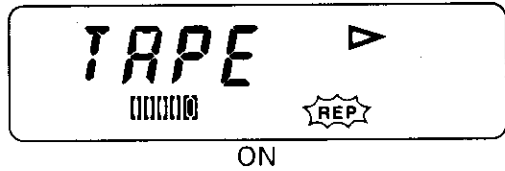

2

After the track being played is over, automatic rewind begins to the beginning of the track selected for repeat play, and the track starts to play again.

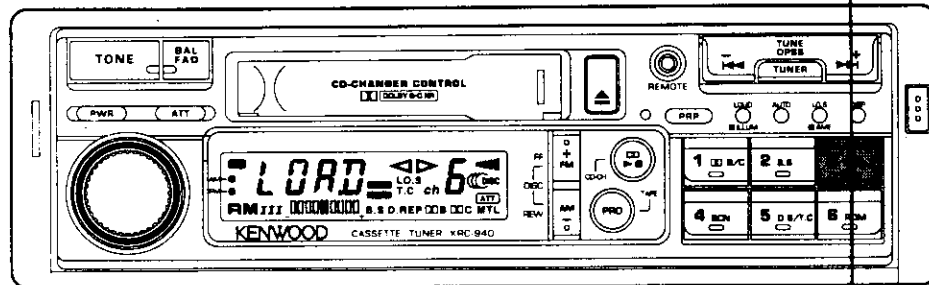

TO RELEASE

Press the Repeat switch again.

NOTE

- Please note that in case of the following tapes, sometimes the REPEAT PLAY does not function properly.
 - When an interval between the music is less than 5 seconds.
 - When a recorded portion of the low sound volume continues for more than 5 seconds.

TUNER CALL

1

Press the Tuner call switch.
(Tuner call indicator lights up.)

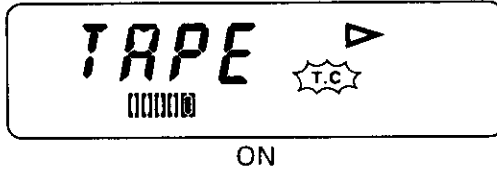

2

You can listen to the tuner while the tape is fast-forwarding or rewinding.

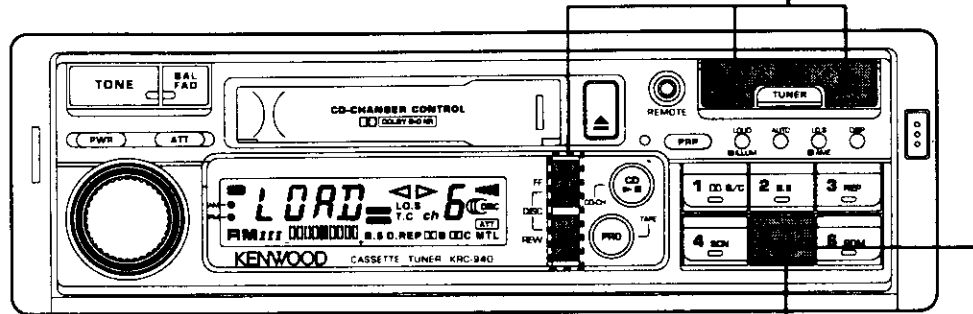

TO RELEASE

Press the Tuner call switch again.

COMPACT DISC PLAY

COMPACT DISC PLAY

Press the CD switch.
(The DISC indicator lights up and the CD play starts.)

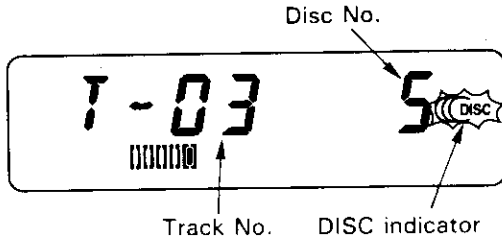

AHEAD/BACKWARD (at high speed)

Operation	Press
Ahead	▶▶ and hold.
Backward	◀◀ and hold.

The Ahead/Backward play is released as soon as the finger is removed from the switch.

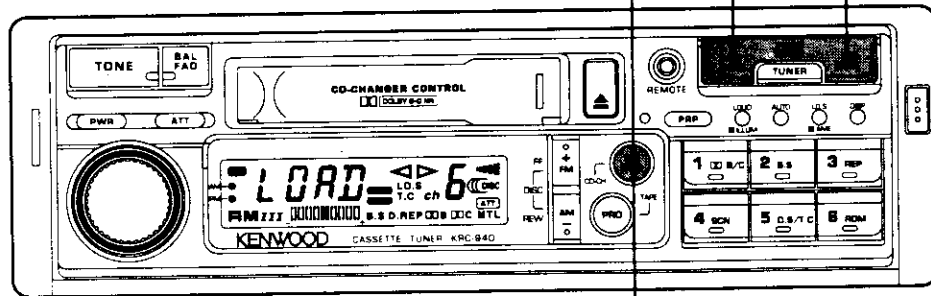

TO STOP CD PLAY

Press the CD switch.
(The DISC indicator disappears and the CD play stops.)

NOTE

At the end of the disc

- When disc reaches the end of the last selection of the next disc starts automatically. At the end of the last disc, the unit will go back to the beginning of the first disc, and the play will restart.

TRACK/DISC SEARCH

BACKWARD TRACK SEARCH

Tap the ◀◀ switch successively until the Track No. display shows the desired track No.



Track No. display

FORWARD TRACK SEARCH

Tap the ▶▶ switch successively until the Track No. display shows the desired track No.



Track No. display

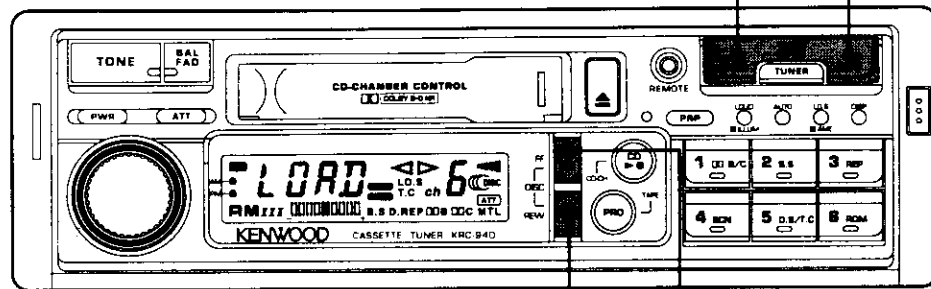

BACKWARD DISC SEARCH

Press the Disc - switch successively until the Disc No. display shows the desired disc No.



Disc No. display

FORWARD DISC SEARCH

Press the Disc + switch successively until the Disc No. display shows the desired disc No.

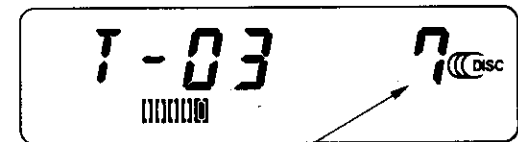

Disc No. display

NOTE

- If BACKWARD TRACK SEARCH is initiated while track No. 1 is being played, the play position always returns to the beginning of track No. 1 and other tracks cannot be searched.
- If FORWARD TRACK SEARCH is initiated while the last track of a disc is being played, no operation takes place.
- The Disc No. display of No. 10 Disc is "0".

TRACK/DISC REPEAT

1 TRACK REPEAT

Press the Repeat switch.
(Repeat indicator lights and the track being played is played repeatedly.)



Track repeat ON

2 DISC REPEAT

Press the Repeat switch again.
(Disc Repeat indicator lights and the Disc being played is played repeatedly.)



Disc repeat ON

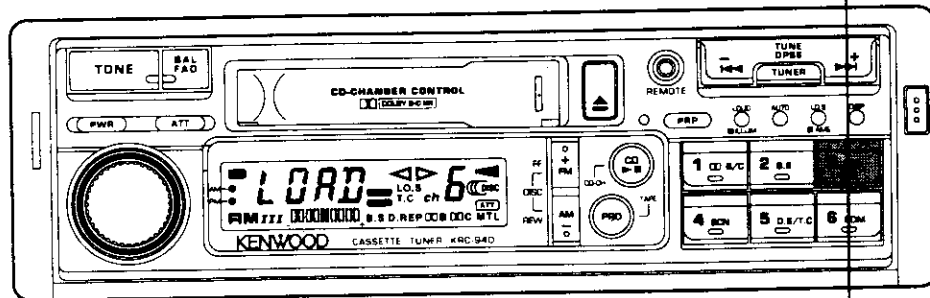

3 TO RELEASE

Press the Track repeat switch again.

1

Press the Track scan switch.
(This initiates TRACK SCAN.)

2

The first 10 seconds of all tracks in
the CDs are played in sequence.
(The Track No. display blinks.)



ON

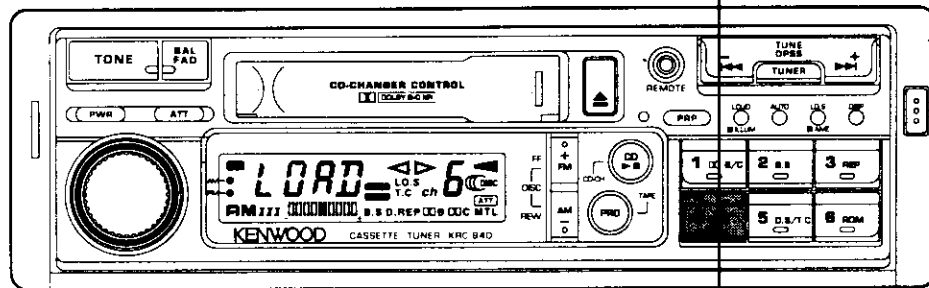

3

When the beginning of a desired
track starts to be played, press the
Track scan switch.
(TRACK SCAN is released and
normal CD play starts.)

NOTE

- Track scan plays the beginnings of all tracks in a disc repeatedly.

DISC SCAN

1

Press the Disc scan switch.
(This initiates DISC SCAN.)

2

The first 10 seconds of each track of the disc will be played one after another.

(While the disc is being scanned, the disc number indicator flashes).

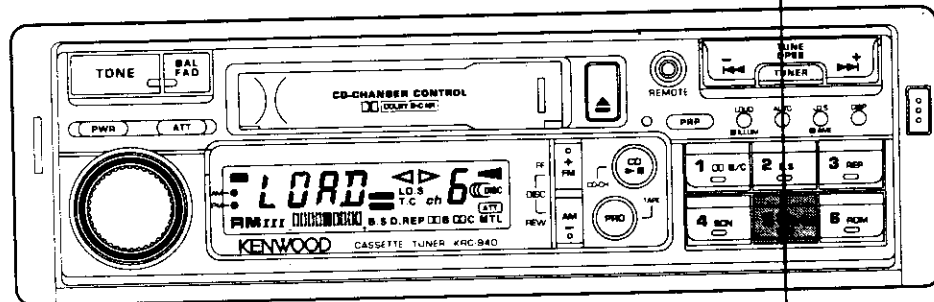

3

Press Disc scan switch for the disc required.
(DISC SCAN will be canceled and operation will return to the normal Disc Play mode.)

1

Press the Random switch.
(The displayed track No. varies one after another.)



During Random Search

2

The tracks in the CD is played in a random order. When all of the tracks in that CD have been played, the next CD is played in a random order.
(" - " of the Track No. display blinks.)

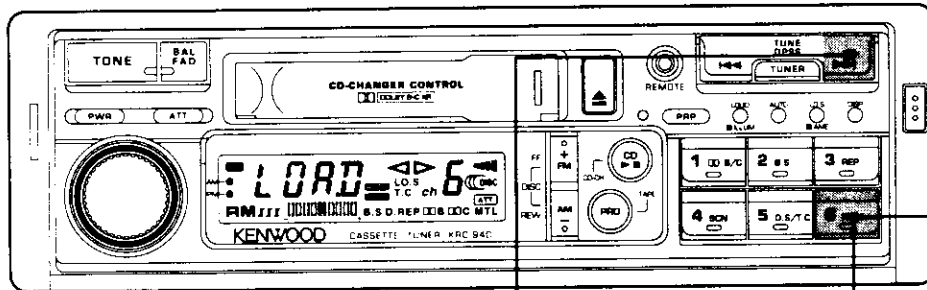

TO SELECT ANOTHER TRACK

Press the ►► switch.
(The next selection is played back.)

TO RELEASE

Press the Random switch again.

HOW TO OPERATE KCA-R2 (Optional)

- By using the separately-sold KCA-R2 wireless remote control unit, you can remotely control the unit as described below.

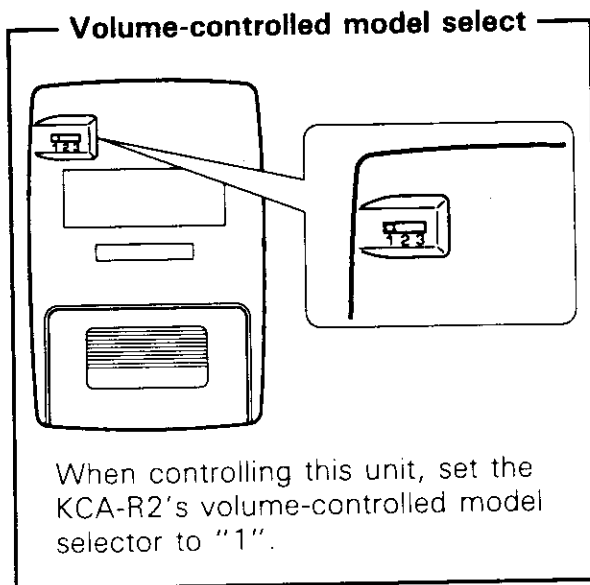

TAPE:

Function in the Tape mode.

TUNER:

Function in the Tuner mode.

CD CHANGER:

Function in the CD changer mode.

Increases the audio volume.

Attenuates the volume quickly. To return to the original volume level, the attenuation can be canceled using one of the following methods.

- Press the switch one more time.
- Press the main unit's Attenuator switch.

TAPE:

Switches the played side to the other side.

Decreases the audio volume.

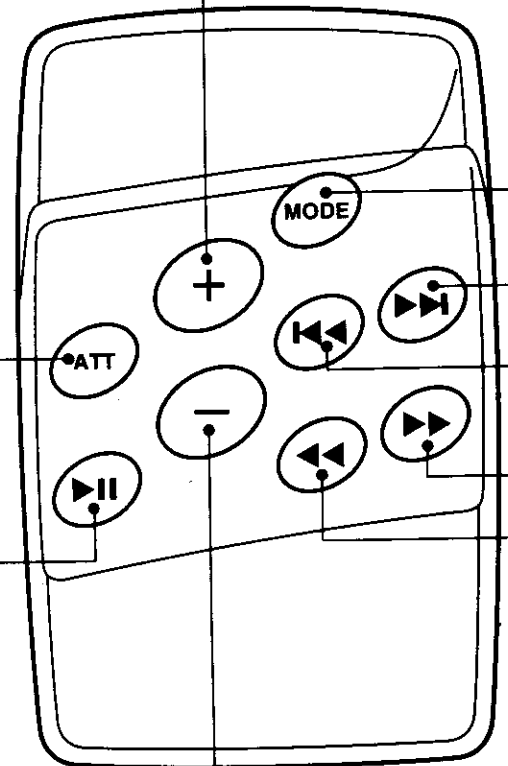

Switches the mode to Tape, Tuner, CD or All Mode Stand-by. The current mode is indicated in the display.

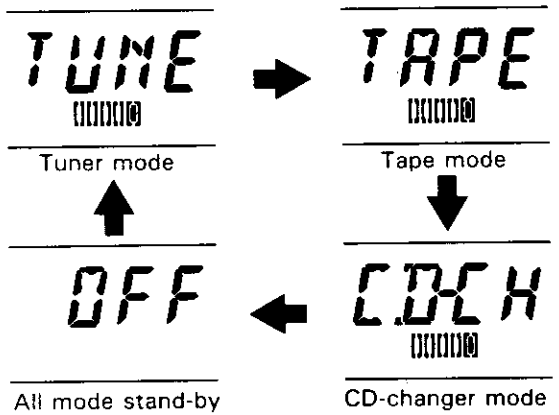

TAPE:

Searches and play the next music.

TUNER:

Increases the receiving frequency.

CD CHANGER:

Searches and play the next track.

TAPE:

Searches and play the previous music.

TUNER:

Decreases the receiving frequency.

CD CHANGER:

Searches and play the previous track.

TAPE:

Rewinds the tape.

TUNER:

Switches to AM bands.

CD CHANGER:

Plays the previous disc.

TAPE:

Fast-forwards the tape.

TUNER:

Switches to FM1/2/3 bands.

CD CHANGER:

Plays the next disc.

SELECTABLE ILLUMINATION

Every time the Illumination switch is pressed for more than 1 second, it will switch over between the colors of green and orange.

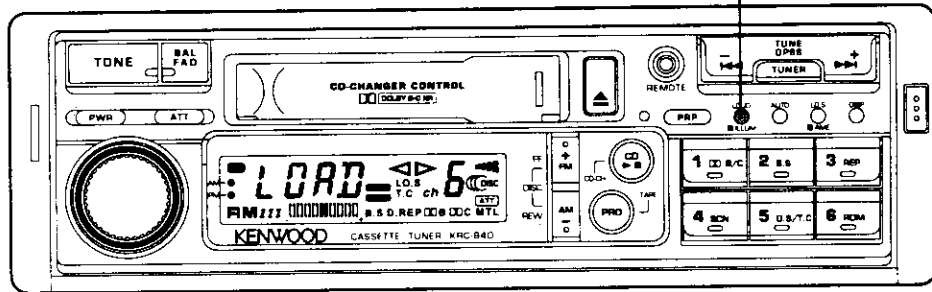

PHONE INTERFACE

1

Connect the unit's Phone interface lead (see P. 41).

2

When a telephone call is received, "CALL" is displayed and the current function stops operating.

CALL
■■■■■■■■■■

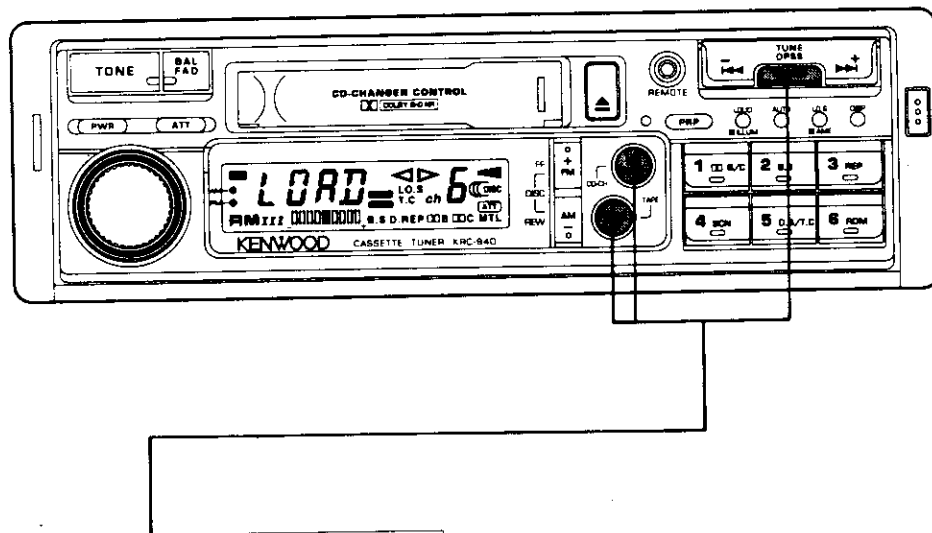

3

When you want to use the unit again, perform an operation for the desired function (see P. 9 ~ 11/26). ("CALL" goes out and the selected function operates.)

NOTE

- This function will not be in operation for the initial 10 seconds of the ignition key switch being switched ON.

THEFT DETERRENT FACEPLATE

■ Remove the faceplate

1

Press the T.D.F. button to release the faceplate lock, then pull off the faceplate.

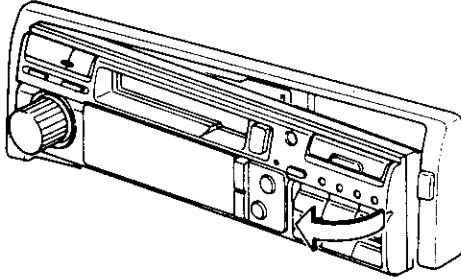

2

Place the faceplate in its storage case with the switch side facing up.

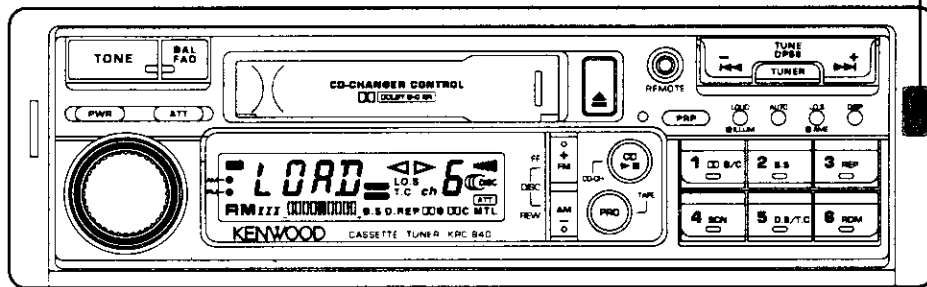
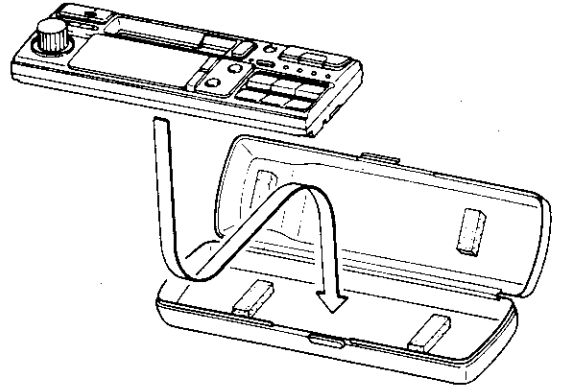

■ Insert the faceplate

1

Align the projections on the faceplate mount with grooves on the left side.

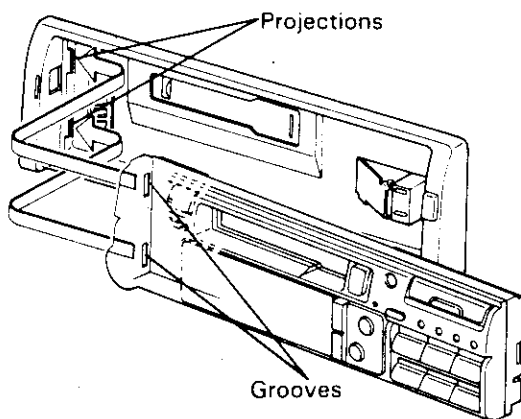

2

Press the right side of the faceplate until it locks into place. (The faceplate is locked.)

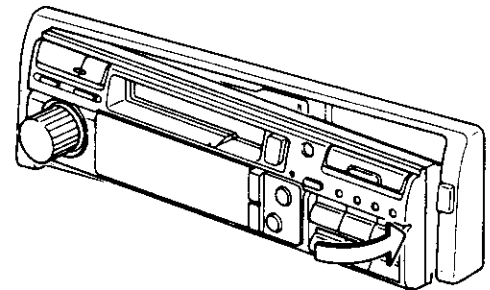

CHANNEL SPACE SELECTION

- The KRC-940 has a channel space select function. Two spacing frequencies are available for both FM and AM, 200 kHz or 50 kHz for FM, and 10 kHz or 9 kHz for AM.

1

Turn the power OFF.

2

Keep on pressing the Preset station switch of "1" and "5"

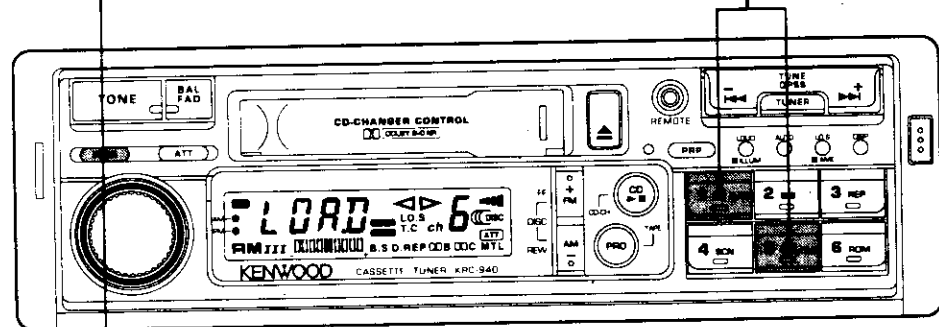

3



Turn ON the power while engaged in the operation of 2. (Channel space will turn to 50 kHz for FM and 9 kHz for AM.)

4

To bring it back the home position, carry out operations of 1-3 again. (Channel space returns to 200 kHz for FM and 10 kHz for AM.)

NOTE

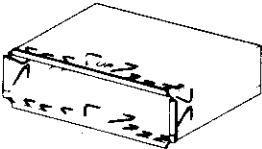
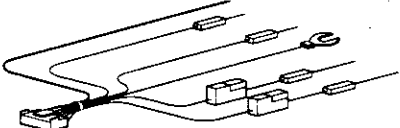
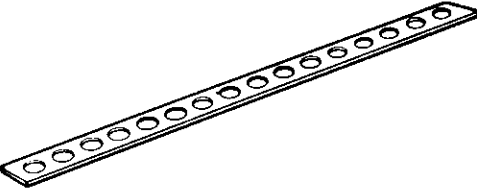
- When the channel space is changed, the memorized contents are erased.
- The channel space selection is not used in United States or Canada.

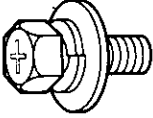
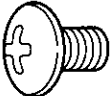
Part name	External View	Number of units
Mounting sleeve		1
Power connection cord		1
Metal mounting strap		1
Removal bracket		1
Washer assembly screw (M4 × 8)		1
Machine screw (M5 × 6)		4

PROCEDURE

- ① Before installation and wiring, remove the ⊖ terminal of the battery to prevent short-circuiting.
- ② Connect the input and output cords of the system. (☞ P. 41)
- ③ Connect the Ground lead (Black) to the metal chassis of the car. (☞ P. 41)
- ④ Connect the Memory backup lead (Yellow). (☞ P. 41)
- ⑤ Connect the Power supply lead (Red). (☞ P. 41)
- ⑥ Install the unit in the car. (☞ P. 42)
- ⑦ Connect the negative ⊖ terminal of the disconnected battery.
- ⑧ After installation, surely press the Reset button.

▲ CAUTION

- A short-circuit may be the cause of blown fuse. A short-circuit is a serious problem that can lead to a fire. Check the wiring and rewire if any wires are short-circuited. After this (or if no short-circuits are found), replace the fuse with one having the same capacity (see indication on fuse box).
- Make sure that unconnected wires and connectors are not in contact with the live chassis (ground) of the car to prevent noise and current from entering the system which can cause it to malfunction or damage the unit. For the same reason, caps on connectors that are not used should not be removed.

■ Example of telephone interface connection.

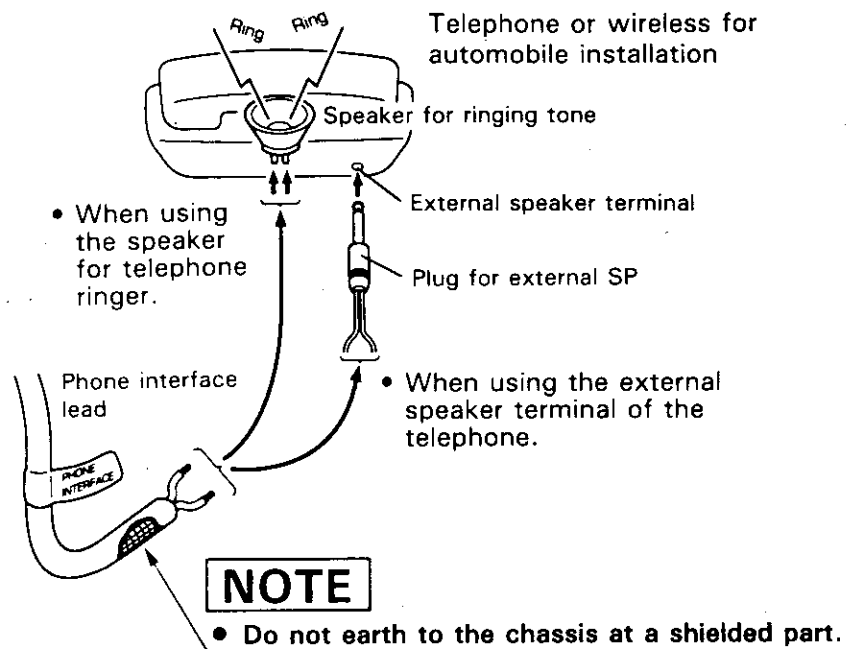

* When extending a cable, be sure to use a shielded cable.

CONNECTIONS

* The circled numbers in the drawing are the "PROCEDURE" numbers listed in page 40.

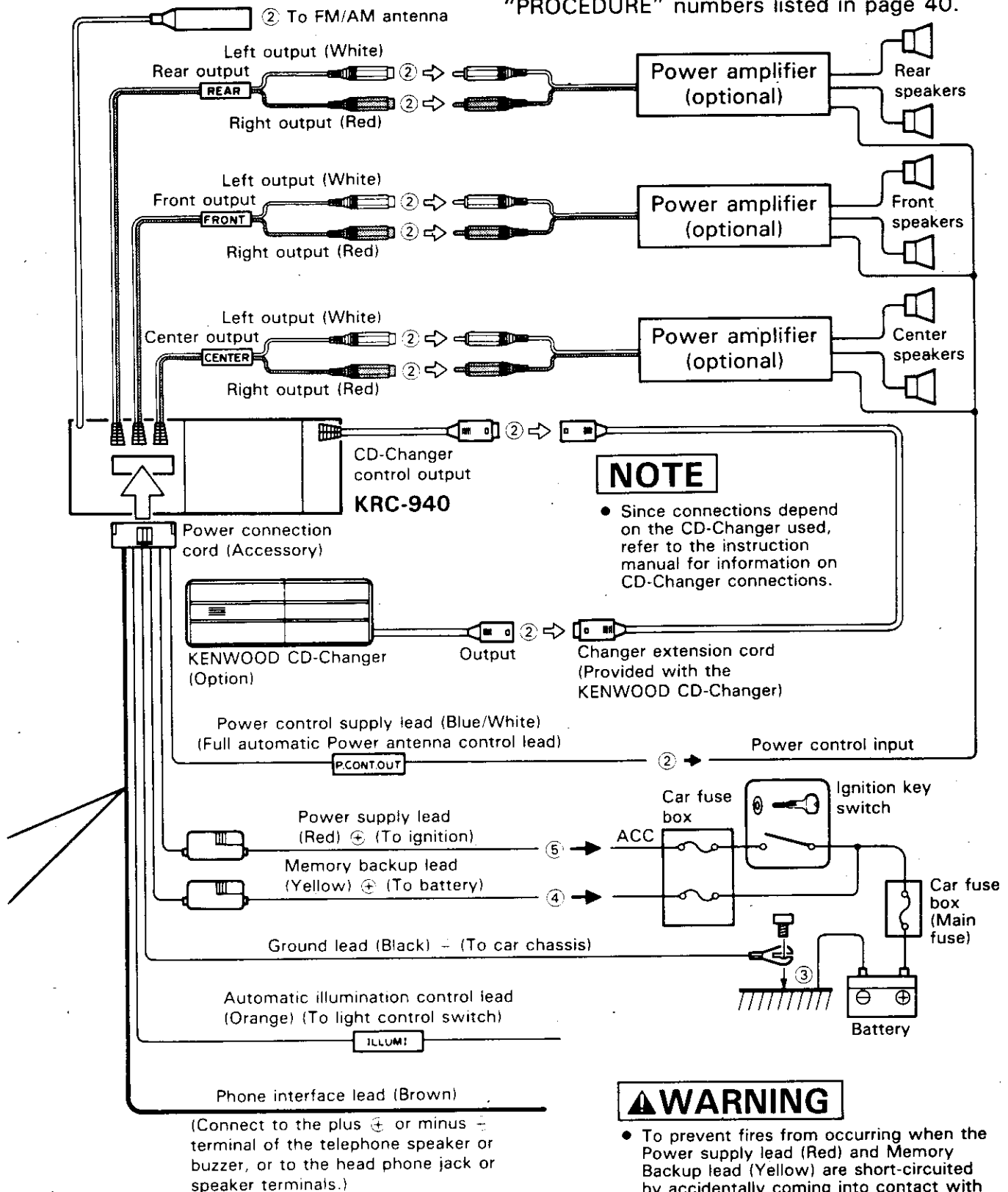

INSTALLATION

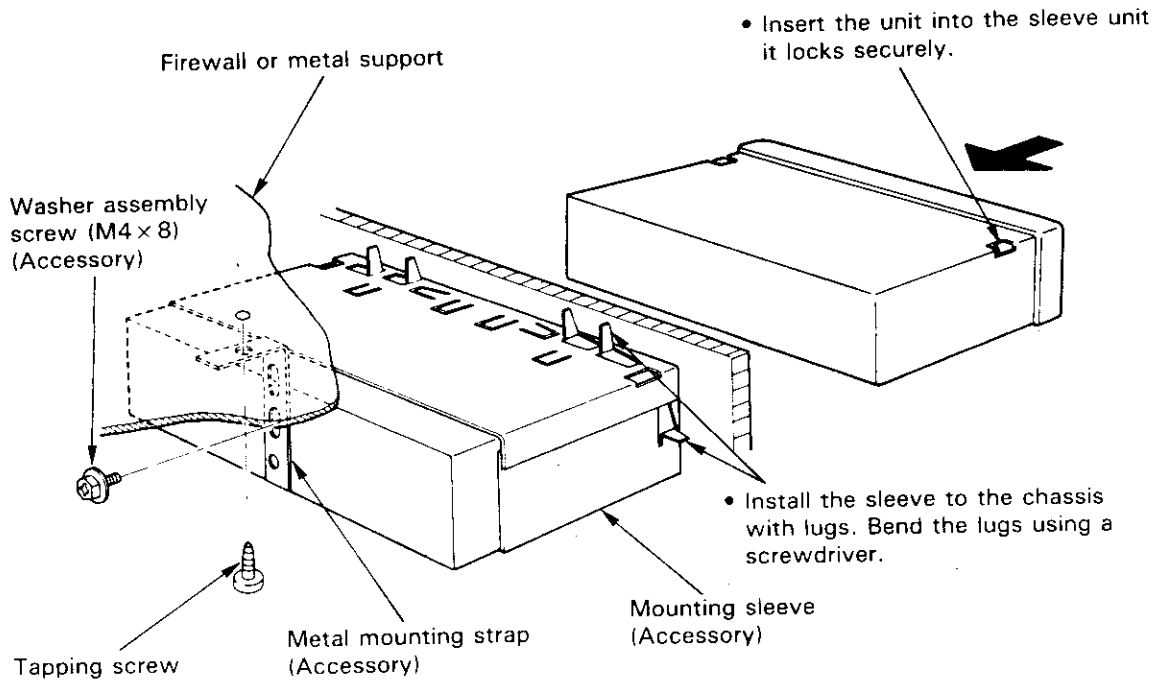

- To install in the Japanese car, fix using the 2 of the holes indicated with ● with Machine screw (M5 x 6) (Accessory).

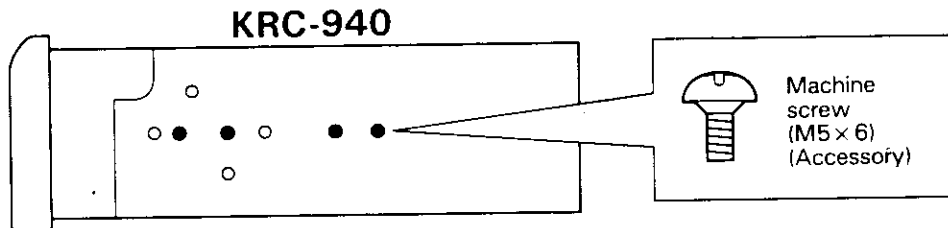

■ How to remove the KRC-940

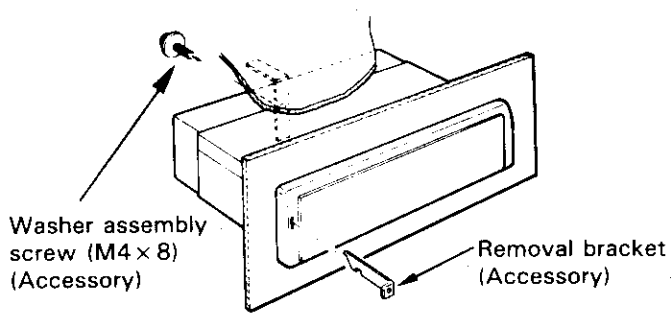

1. Remove the Washer assembly screw (M4 × 8) retaining the back panel of the KRC-940. Then, insert removal bracket into the hole.

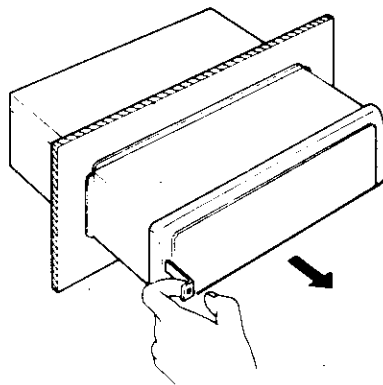

2. Pull out the removal bracket by hooking the fingers simultaneously.

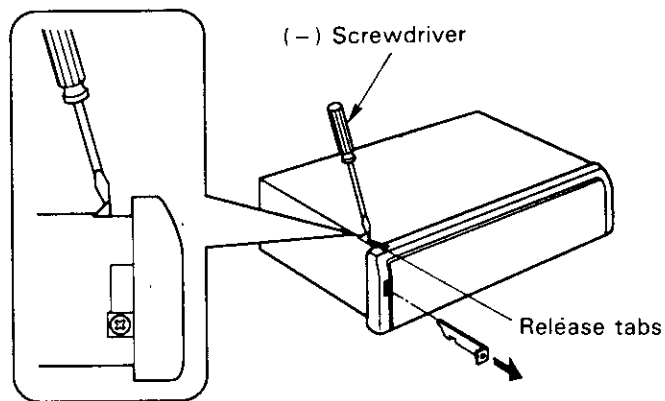

3. To release the removal bracket, use a screwdriver to press down the release tabs on the side of the chassis and pull the removal brackets.

TROUBLESHOOTING GUIDE

What often appears to be a malfunction is often due to user error in operation or connection. When trouble occurs with your unit, please check the following before calling for service.

Symptom	Cause	Remedy
No sound one channel	The balance/fader control is extremely rotated to one side.	Adjust the balance/fader control.
Poor reception	The antenna is not extended.	Extend the antenna.
Tonal quality is inferior. Tape creaks.	Head is stained.	Carry out head cleaning.
Operation switches do not function. Phone interface does not function.	Correct operation is not obtained due to a sudden change in the power voltage, etc. Phone interface lead is not connected correctly.	Press the Reset button of the front panel. Connect it correctly according to the connecting method.
Phone interface functions although it is not used. (Displays "CALL" indication).	Conductor is contacting chassis and so on as phone interface lead is clipped or the cap at the tip is off.	Wire in such a way that the conductor of phone interface lead does not contact chassis and so on.

■ When the KENWOOD CD-changer is connected:

Symptom	Cause	Remedy
CD play does not start.	Power switch is not turned ON.	Turn the Power switch ON, then press the CD switch.
The specified disc is not played and the next disc is played.	<ol style="list-style-type: none"> The specified disc is too dirty. The disc is placed upside down. Two discs are set in the same position. The specified disc is placed in a position with a different number. The disc is damaged or scratched seriously. 	<ol style="list-style-type: none"> Clean the disc. Eject the magazine and re-insert the disc correctly. Eject the magazine and set each disc correctly. Eject the magazine to check the disc number and the position number, then specify again. Play other discs.
No sound is output while the changer indicator is shown.	<ol style="list-style-type: none"> Volume is set to the minimum level. The incorporated microcomputer is not operating correctly. System connections are made imperfectly (power cord, connection of pre-out jacks, or speaker connections, etc.). 	<ol style="list-style-type: none"> Increase the volume level. Press the Reset button of this unit. Check the connections according to the instruction manual. If anything is wrong, reconnect it correctly.
Even when the required track is specified, the specified track is not played or the player does not function.	The player is set to RANDOM PLAY.	Release RANDOM PLAY.

Other than the previous, this unit displays various error indications to show the following messages.

E-01: No disc magazine in the changer, or the magazine is not set completely.

E-02: No discs in the disc magazine.

E-04: Disc is too dirty.

Condensation has occurred on the disc, or water drops are on the disc.

Disc is set upside down.

E-99: Operation incorrect due to something being defective.

Press the Reset button on this unit.

If the "E-99" indication does not disappear with this operation, consult your nearest KENWOOD Service Agent.

E-0D:

- When the temperature exceeds 60°C, the protection circuit is engaged to stop any operation. At this time, this indication will appear.
- Open a window or turn the air-conditioner ON to lower the temperature. After a while, this indication will go out.
- This indication also appears for several seconds when making connections, or when the Reset button is pressed.

LOAD: This indication appears while a disc is being changed inside the changer.

NOTE

Random play, Track repeat or Track/Disc scan cannot be initiated while the load indication is displayed.

* When no indicator appears in this unit and only illumination appears, the cable connector may nearly be disconnected.

SPECIFICATIONS

Specifications subject to change without notice.

FM Tuner Section

Frequency Range (200 kHz space)	87.9 MHz ~ 107.9 MHz
(50 kHz space)	87.5 MHz ~ 108.0 MHz
Usable Sensitivity	12.0 dBf (1.1 μ V/75 ohms)
50 dB Quieting Sensitivity	15.2 dBf (1.6 μ V/75 ohms)
Frequency Response (± 3 dB)	30 Hz ~ 15 kHz
Signal to Noise Ratio	73 dB
Selectivity	100 dB
Capture Ratio	1.5 dB
Image Response Ratio	70 dB
IF Response Ratio	120 dB
Stereo Separation (1 kHz)	40 dB

AM Tuner Section

Frequency Range (10 kHz space)	530 kHz ~ 1,700 kHz
(9 kHz space)	531 kHz ~ 1,611 kHz
Usable Sensitivity	28 dB (30 μ V)

Cassette Deck Section

Tape Speed	4.76 cm/sec
Wow & Flutter (WRMS)	0.08% (WRMS)
Fast Winding Time (C-60)	100 sec
Frequency Response (120 μ s)	30 Hz ~ 20 kHz (± 3 dB)
(70 μ s)	30 Hz ~ 21 kHz (± 3 dB)
Stereo Separation (1 kHz)	43 dB
Signal to Noise Ratio (Dolby NR OFF)	58 dB
(Dolby-B NR ON)	67 dB
(Dolby-C NR ON)	73 dB

Audio Section

Tone Action	Bass: 70 Hz ± 10 dB
	Mid-Bass: 200 Hz ± 10 dB
	Treble: 10 kHz ± 10 dB
Preout level/load	1,000 mV (MAX.)/10 kohms

General

Operating Voltage	14.4 V (11 ~ 16 V allowable)
Current Consumption	0.8 A at Rated Power
Installation size (W x H x D)	182 x 52 x 154 mm
	(7-3/16 x 2-1/16 x 6-1/16 in.)
Weight	3.5 lb (1.6 kg)